

Switches

Standard Family Code LTKE 900 1 CO

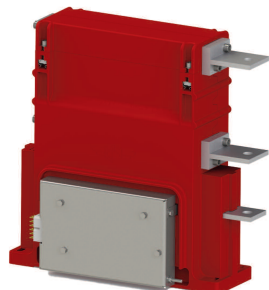

Description

One pole change over disconnecter switch, electric motor control by electronic device, 2 positions, bi-stable.

Reference standard IEC 60077-2.

Type	LTKE900
Number of Poles	1 CO
Mounting Position	Horizontal - Vertical ¹
Control Voltage Range [V ^{dc}]	24-110 ¹
Auxiliary Contact Blocks	3 (1NO+1NC)
Block Type	Integrated
Main Contacts tips Material	Cu
Layout Drawing	D54144

¹ To be specified in order phase

Electrical Characteristics

Rated Operational Voltage [V _{ac} / V _{dc}]	3600
Max Operational Voltage [V _{oc} / V _{dc}]	4400
Conventional Free Air Thermal Current [A] at 40°C ²	1050
Conventional Free Air Thermal Current [A] at 75°C ²	900
Main circuit resistance [μΩ] ³	200
DC-Rated Operational Current (τ=15ms) [A]	0
DC-Maximum Breaking Capacity (τ=5ms) @ U _e [A]	0.2
AC-Maximum Breaking Capacity (cosφ=0,8) @ U _e [A]	0.5
Short Circuit Withstand Capacity for 5/50/100 ms [kA]	90/75/50
Fault Making Capacity @ 100V (τ=0ms) [A]	50
Component Category / Operational Frequency Class	A4 / C3

² Device cabled according IEC 60947

³ In new and clean condition for power loss calculation only

Insulation Characteristics

Rated Insulation Voltage @ OV4/PD3A [V]	3700
Rated Insulation Voltage @ OV3/PD3 [V]	4800
Rated impulse voltage [kV]	30
Rated Power Frequency Withstand Voltage (50Hz; 60")	
Between HV circuit and LV circuit+Earth [V]	11600
Between open contacts [V]	9200
Between each pole (if more than 1) [V]	11600
Between LV circuit and Earth [V]	1500
Minimum clearance distance between open contacts [mm]	40
Minimum clearance distance between HV circuit and LV circuit+earth [mm]	40
Minimum creepage distance [mm]	80
Comparative Tracking Index (CTI) (IEC 60112) [V]	600

Minimum clearances [mm] from:				
Rated Operational Voltage	X	Y	Z	
3600V	Metal Parts	50	50	30
	Plastic Parts	30	30	30

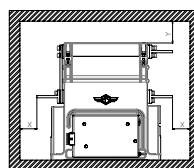

HORIZONTAL
MOUNTING ⁴

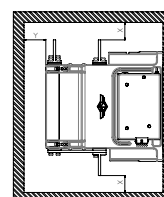

VERTICAL
MOUNTING ⁴

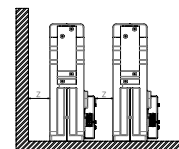

⁴ OTHER MOUNTING POSITIONS NOT ALLOWED

The technical specifications reported are not binding and they should be agreed in the related contract.



Microelettrica Scientifica

Switches

Standard Family Code
LTKE 900 1 CO

Mechanical Characteristics

Mechanical Endurance (cycles)	2.5x10 ⁵
Shock and Vibrations (IEC61373)	Cat. 1 - Class B
Weight [kg]	11

Control Circuit

Control Voltage Range	0.7U _c ÷ 1.25U _c
Power Consumption (U _c and T = 20°C) at Pick Up - when operating - at Holding [W]	100 - 30 - 0
Mechanical Operation Time (U _c and T = 20°C) when Closing - Opening [ms]	3000 - 3000
Mechanical Operation Time (in the worst condition) [ms]	4000 - 4000
Electrical Connections	Low voltage connector SMS 18GE63

Auxiliary contacts

Tips material	Silver Alloy
Rated Operational voltage [V _{ac} / V _{dc}]	250
Rated Current [A]	5

Environmental Conditions

Stock Temperature Range	-50°C ÷ +85°C
Operational Temperature Range up to 1000m	Tx (-40°C ÷ +75°C) ⁵
Operational Temperature Range up to 2000m	T2 (-40°C ÷ +65°C) ⁵
Humidity	10 ÷ 95% RH ⁶

⁵ According to IEC50125-1

⁶ According to IEC 62498-1

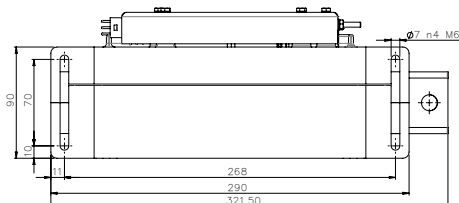
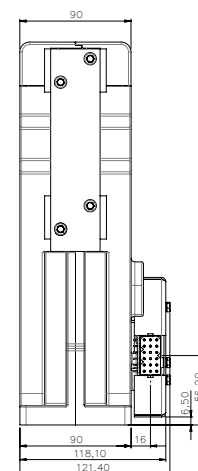
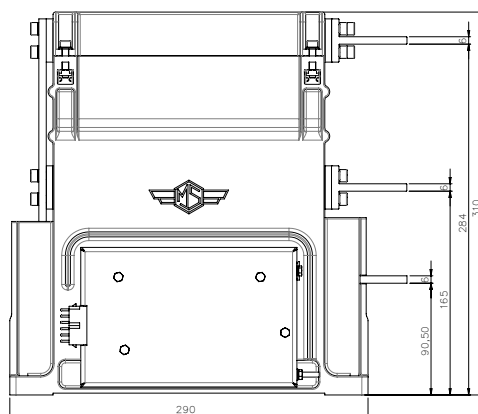
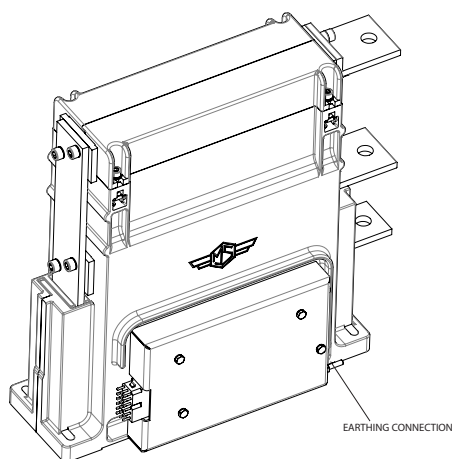

This publication may be subject to alteration without prior notice. Therefore, a printed copy of this document may not be the latest revision. Please contact your local representative for the latest update. The trademarks MS Microelettrica Scientifica, Knorr and Knorr-Bremse as well as the figurative mark "K" are registered. Copyright © Knorr-Bremse AG and Microelettrica Scientifica SpA - all rights reserved, including industrial property rights application. Knorr-Bremse AG and Microelettrica Scientifica SpA retain any power of disposal, such as for copying and transferring.

Microelettrica Scientifica S.p.A. - 20090 Buccinasco (MI) - V. Lucania, 2 - Italy
Tel. +39 02 575731 - Fax +39 02 57510940 - E-Mail: info@microelettrica.com

Rev.00 09/2018_RM